

## Dugókulcs, 1/4"

H135 005 - 010

### H135 010

Dugókulcs, 1/4" SUPERLOCK

Alapanyag: króm-vanádium acél, sima matt króm felület.

Kivitel: Suprelock belső profillal a tökéletes nyomatékátvitel érdekében a csavarfejek lapjára feszül.



911.1404-1414

### H135 005

Dugókulcs, 1/4"

króm-vanádium krómozott, teljesen polírozott golyófogó horonnyal  
Hossz:25 mm



25-6

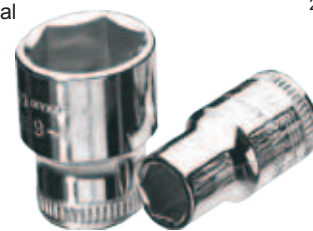

Méretkód mm	4	4,5	5	5,5	6	7	8	9	10	11	12	13	14

## Dugókulcs, 1/4", „TRIPLEplus”

H135 015



Dugókulcs, 1/4" SUPERLOCK

Alapanyag: olajedzett króm-vanádium acél.

Kivitel: Triple plus profillal, amely lehetővé teszi egy kulccsal négy különböző fejkialakítású csavar meghúzását. Egyaránt alkalmas hatlapú, tizenkétszögű és külső TORX-E profilra, sőt coll méretre is.

Hossz:25 mm



916.1404-1414

Méretkód mm	4	4,5	5	5,5	6	7	8	9	10	11	12	13	14

## Dugókulcs, 1/4", hosszú

H135 020 - 027

Méretkód Méret mm	H135...		
	020	025	027
4	•	•	•
4,5		•	•
5	•	•	•
5,5			•
6	•	•	•
7	•	•	•
8	•	•	•
9	•	•	•
10	•	•	•
11	•	•	•
12	•	•	•
13	•	•	•
14		•	•

### H135 020

Dugókulcs hosszú 1/4" SUPERLOCK

Alapanyag: króm-vanádium acél,

sima matt króm felület

Kivitel: Suprelock belső profillal a tökéletes nyomatékátvitel érdekében a csavarfejek lapjára feszül.

Hossz: 50 mm



911.1426-1433

### H135 025

Dugókulcs hosszú 1/4" TRIPLEplus

Alapanyag: olajedzett króm-vanádium acél

Kivitel: Triple plus profillal, amely lehetővé teszi egy kulccsal négy különböző fejkialakítású csavar meghúzását. Egyaránt alkalmas hatlapú, tizenkétszögű és külső TORX-E profilra, sőt sok collméretre is.

Hossz: 50 mm



916.1424-1434

### H135 027

Dugókulcs, 1/4" hosszú

Alapanyag: króm-vanádium, krómozott,

teljesen polírozott golyófogó horonnyal.

Hossz:50 mm



25-19



## Dugókulcs, 1/4"

H135 030 - 040

Méretkód coll	H135...		
	030	035	040
1/8			•
5/32			•
3/16	•	•	•
7/32	•	•	•
1/4	•	•	•
9/32	•	•	•
5/16	•	•	•
11/32	•	•	•
3/8	•	•	•
7/16	•	•	•
1/2	•	•	•
9/16	•	•	•

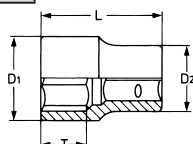

### H135 030

Dugókulcs 1/4" CHROMEplus collos kivitel  
Alapanyag: olajdzett króm-vanádium acél  
Kivitel: Suprelock belső profillal a tökéletes nyomatékátvitel érdekében a csavarfejek lapjára feszül.  
Hossz: 25 mm

**KSTOOLS**  
918.1511-1520

### H135 035

Dugókulcs hosszú 1/4" CHROMEplus collos kivitel  
Alapanyag: olajdzett króm-vanádium acél  
Kivitel: Suprelock belső profillal a tökéletes nyomatékátvitel érdekében a csavarfejek lapjára feszül.  
Hossz: 50 mm

**KSTOOLS**  
918.1521-1530

### H135 040

Dugókulcs, 1/4"  
króm-vanádium krómozott,  
teljesen polírozott golyófogó horonnyal  
Hossz: 25 mm

**HEYCO**  
25-6

## Dugókulcs, 1/4" BIT befogással

H135 050 - 055

Méretkód mm	Ø	Ø	L
5,0x152	5,0	11,0	152,0
5,5x50	5,5	11,0	50,0
5,5x65	5,5	9,5	65,0
5,5x152	5,5	11,0	152,0
6,0x50	6,0	11,0	50,0
6,0x65	6,0	11,0	65,0
6,0x152	6,0	11,0	152,0
7,0x50	7,0	11,0	50,0
7,0x65	7,0	11,0	65,0
7,0x152	7,0	11,0	152,0
8,0x50	8,0	12,5	50,0
8,0x65	8,0	12,5	65,0
8,0x152	8,0	12,5	152,0
9,0x50	9,0	14,0	50,0
9,0x65	9,0	14,0	65,0
9,0x152	9,0	14,0	152,0
10,0x50	10,0	14,0	50,0
10,0x65	10,0	14,0	65,0
10,0x152	10,0	14,0	152,0
11,0x50	11,0	16,0	50,0
11,0x65	11,0	16,0	65,0
11,0x152	11,0	16,0	152,0
12,0x50	12,0	18,0	50,0
12,0x65	12,0	17,0	65,0
12,0x152	12,0	18,0	152,0
13,0x50	13,0	18,0	50,0
13,0x65	13,0	19,0	65,0
13,0x152	13,0	18,0	152,0

Méretkód coll	Ø	Ø	L
3/16x152	3/16	11,0	152,0
1/4x50	1/4	11,0	50,0
1/4x65	1/4	11,0	65,0
1/4x152	1/4	11,0	152,0
9/32x152	9/32	11,0	152,0
5/16x50	5/16	12,5	50,0
5/16x65	5/16	12,5	65,0
5/16x152	5/16	12,5	152,0
11/32x152	11/32	14,0	152,0
3/8x50	3/8	14,0	50,0
3/8x65	3/8	14,0	65,0
3/8x152	3/8	14,0	152,0
7/16x50	7/16	16,0	50,0
7/16x152	7/16	16,0	152,0
1/2x152	1/2	18,0	152,0
9/16x152	9/16	20,0	152,0
5/8x152	5/8	22,0	152,0

### H135 050

Befogó: 1/4" hatszög, DIN 3126-E 6,3  
Belső hatszög, mágnes nélkül.

**Wera**  
869/4



### H135 055

Befogó: 1/4" hatszög, DIN 3126-E 6,3  
Belső hatszög, erős állandó mágnessel.

**Wera**  
869/4M



## Dugókulcs, gépi 1/4"

H135 057

Méretkód mm	5,5	6	7	8	9	10	11	12	13	14
----------------	-----	---	---	---	---	----	----	----	----	----

Méretkód coll	3/16"	1/4"	5/16"	3/8"	7/16"
------------------	-------	------	-------	------	-------

Hatszög fejfel  
Alapanyag:króm-molibdénacél, foszfátzott felülettel  
DIN 3129 barnított  
Hossz: 23 mm

**KSTOOLS**  
515.1541-1556



## Dugókulcs, 1/4", „TORX-E”

H135 060 - 065

Méretkód	mm	H135...	
		060	065
E 4	3,86	•	•
E 5	4,75	•	•
E 6	5,74	•	•
E 7	6,22	•	•
E 8	7,52	•	•
E 10	9,42	•	•
E 11			•

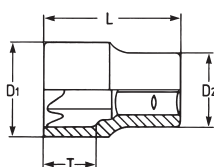

### H135 060

Króm-vanádium krómozott, teljesen polírozott golyófogó horonnyal  
Hossz: 25 mm



HEYCO

25-20

### H135 065

Alapanyag: króm-vanádium acél, sima matt króm felület.  
Hossz: 25 mm



KSTOOLS

911.4313-4350

## Rátűzőkulcs, 1/4", lapos

H135 070 - 075

Méretkód	mm	mm	H135...	
			070	075
3,0	3,0	0,5	•	
3,5	3,5	0,6	•	
4,0	4,0	0,8	•	•
5,0	5,0			•
5,5	5,5	1,0	•	
6,5	6,5	1,2	•	•
7,0	7,0	1,2	•	•
8,0	8,0	1,2	•	•



### H135 070

Alapanyag: króm-vanádium, krómozott  
A bitek: különleges acél, foszfátzott.  
L=34,5 mm



HEYCO

25-30

### H135 075

Alapanyag: króm-vanádium acél, sima matt króm felület.  
L=37mm



KSTOOLS

911.1418-1420

## Rátűzőkulcs, 1/4", hatszög

H135 080 - 085

Méretkód	mm	H135...	
		080	085
2,0	2,0		•
2,5	2,5		•
3,0	3,0	•	•
4,0	4,0	•	•
5,0	5,0	•	•
6,0	6,0	•	•
7,0	7,0	•	•
8,0	8,0	•	•



### H135 080

Belső nyílású hatszögcsavarokhoz  
A bitek: különleges acél foszfátzott  
Alapanyag: króm-vanádium, krómozott.  
L=34,5 mm

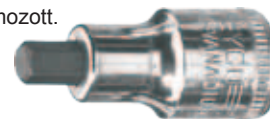

HEYCO

25-31

Collos méretben (1/8"; 5/32"; 3/16"; 7/32"; 1/4"; 5/16") is kapható, katalógusszáma szintén Heyco 25-31.

### H135 085

Alapanyag: króm-vanádium acél, sima matt króm felület.  
L=37 mm



KSTOOLS

911.1436-1441

## Rátűzőkulcs, 1/4", keresztornyos, PH

H135 090 - 095

Méretkód	H135...	
	090	095
PH 0		•
PH 1	•	•
PH 2	•	•
PH 3	•	•
PH 4	•	•



### H135 090

Keresztornyos csavarokhoz PHILLIPS-RECESS  
A bitek: különleges acél foszfátzott.  
L=34,5 mm



HEYCO

25-32

### H135 095

Alapanyag: króm-vanádium acél, sima matt króm felület.  
L=37 mm



KSTOOLS

911.1415-1417

## Rátűzőkulcs, 1/4", keresztornyos, PZ

H135 100 - 105

Méretkód	H135...	
	100	105
PZ 0		•
PZ 1	•	•
PZ 2	•	•
PZ 3	•	•
PZ 4	•	•



### H135 100

POZIDRIV® keresztornyos csavarokhoz.  
Alapanyag: króm-vanádium acél  
A bitek: különleges acél, foszfátzott. L=34,5 mm



25-35

### H135 105

POZIDRIV® keresztornyos csavarokhoz.  
Alapanyag: króm-vanádium acél, sima matt króm felület.  
L=37 mm



911.1401-1403

## Rátűzőkulcs, 1/4", „TORX”

H135 110 - 120

Méretkód	mm	H135...		
		110	115	120
TX 6	1,67	•		
TX 7	1,99	•		
TX 8	2,31	•	•	
TX 9	2,50	•	•	•
TX 10	2,74	•	•	•
TX 15	3,27	•	•	•
TX 20	3,86	•	•	•
TX 25	4,43	•	•	•
TX 27	4,99	•	•	•
TX 30	5,52	•	•	•
TX 40	6,65	•	•	•



### H135 110

Rátűzőkulcs 1/4" TORX  
Belső TORX® csavarokhoz  
Alapanyag: króm-vanádium acél  
A bitek: különleges acél, foszfátzott.  
L=34,5 mm



25-36

### H135 115

Rátűzőkulcs 1/4" TORX  
Alapanyag: króm-vanádium acél, sima, matt króm felület.  
L=38 mm



911.1442-1449

### H135 120

Rátűzőkulcs 1/4" TORX BO  
Alapanyag: króm-vanádium acél, sima, matt króm felület.  
L=37 mm



911.1461-1468

## Rátűzőkulcs készlet, 1/4", „TORX”

H135 125

Rátűzőkulcs készlet, 1/4" TORX® és TORX-E csavarokhoz.  
Alapanyag: króm-vanádium krómozott, teljesen polírozott  
Kivitel: 17 részes készlet, fémdobozban.

Szerszám	Tartalom Méret
	E 4, E 5, E 6, E 7, E 8, E 10
	TX 6, TX 7, TX 8, TX 9, TX 10, TX 15, TX 20, TX 25, TX 27, TX 30, TX 40



25-50-E/T

## Rátűzőkulcs készlet, 1/4", „TORX”

H135 130

Kivitel: 7 részes krómozott készlet fém sínen  
Alapanyag: króm-vanádium acél, sima matt króm  
Alkalmazás: belső kulcsnyílású TORX csavarokhoz.

Szerszám	Tartalom Méret
	TX 10, TX 15, TX 20, TX 25, TX 27, TX 30, TX 40 Dugókulcs tartó fém clip 7 r.



911.1458

## Egyenes hajtószár, 1/4"

H135 195 - 200

### H135 195

Egyenes hajtószár hajtómaggal 1/4"  
Króm-Vanádium, krómozott, részben polírozott.  
Golyós rögzítéssel. 114 mm hosszú.

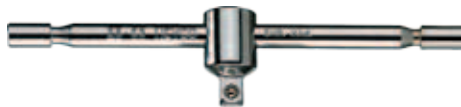

HEYGO

25-03

### H135 200

Egyenes hajtószár hajtómaggal 1/4"  
Króm-vanádium acél, sima matt króm felület  
Golyós rögzítéssel. 110 mm hosszú.



KSTOOLS

911.1425

## Toldószár, 1/4"

H135 210 - 233

### H135 210

Alapanyag: króm-vanádium, krómozott, teljesen polírozott.  
Golyós rögzítéssel.



HEYGO

25-04  
25-05  
25-05-1

### H135 220

Alapanyag: króm-vanádium acél, sima matt króm felület



KSTOOLS

911.1423  
911.1424  
911.1451

### H135 230

Dönthető kivitel CHROMEplus  
Alapanyag: olajedzett króm-vanádium acél  
Kivitel: 20°-ban dönthető, külső 1/4" négyszöggel



KSTOOLS

918.1403  
918.1401  
918.1402  
918.1458

### H135 225

Kuplungos LOKPLUS  
Alapanyag: olajedzett króm-vanádium acél.



KSTOOLS

919.1402  
919.1404  
919.1406

### H135 233

Toldószár gépi, 1/4"  
Alapanyag: króm-molibdén acél, foszfátzott felülettel.



KSTOOLS

515.1560

Méretkód	H135...				
	210	220	225	230	233
L mm					
50		•		•	•
55	•				
75					
100		•	•	•	
105	•				
150	•	•	•	•	
250			•	•	

## Kardáncsukló, 1/4"

H135 235 - 245

### H135 235

Alapanyag: króm-vanádium, krómozott,  
teljesen polírozott.  
Golyós rögzítéssel. 25 mm hosszú.



HEYGO

25-06

### H135 240

Alapanyag: króm-vanádium acél,  
sima matt króm felület.  
Hossz: 38 mm



KSTOOLS

911.1450

### H135 245

Rugós CHROMEplus  
Alapanyag: olajedzett króm-vanádium acél.  
45°-os szögben dönthető  
Hossz: 35 mm



KSTOOLS

919.1450

## Csuklós hajtókar, 1/4"

H135 250

Alapanyag: króm-vanádium, krómozott, teljesen polírozott.  
Golyós rögzítéssel. 155 mm hosszú.



HEYGO

25-07

## Nyeles hajtószár, 1/4"

H135 255 - 265

### H135 255

Alapanyag: króm-vanádium, krómozott, teljesen polírozott.  
Golyós rögzítéssel. 145 mm hosszú.



HEYGO

25-08

### H135 260

Alapanyag: króm-vanádium acél, sima matt króm felület  
Kivitel: kétkomponensű ergonomiai nyél,  
150 mm hosszú.



KSTOOLS

911.1434

### H135 265

Flexibilis 1/4"  
Alapanyag: polírozott króm-vanádium acél  
Alkalmazás: dugókulcsokhoz csatlakoztatható  
200 mm hosszú.



KSTOOLS

911.1120

## Dugókulcs készlet + rátűzőkulcs, 1/4", „SUPERLOCK”

H135 355

Szerszám	Tartalom Méret
 	1/4" 4-4,5-5-5,5-6-7-8-9-10-11-12-13-14 mm
	1/4" 4-5,5-7 mm
	1/4" PH 1-2-3
	1/4" PZ 1-2
	1/4" 3-4-5-6-7-8 mm
	1/4" TX 10-15-20-25-27-30-40
	1/4" 50-100 mm
	1/4" 150 mm
	Átalakító szár négyszög-hatszög 1/4"
	1/4" 35 mm
	1/4" 110 mm
	1/4" 150 mm
	1/4" 145 mm
	1-1,5-2-2,5 mm

Alapanyag: króm-vanádium acél, sima matt króm felület  
Kivitel: 46 részes krómozott készlet, műanyag dobozban Suprelock belső profillal, a tökéletes nyomtétákvitel érdekében a csavarfejek lapjára feszül.  
Hajtókar: irányváltós, gyorskioldós, 45 fogú racsnyal, 8°-onkénti racsnyás.











**KSTOOLS**

911.0646



## Dugókulcs készlet + rátűzőkulcs, 1/4"

H135 370

Szerszám	Tartalom Méret
 	1/4" 4-4,5-5-5,5-6-7-8-9-10-11-12-13 mm
	1/4" 5,5-6,5 mm
	1/4" 3-4-5-6-8 mm
	1/4" PH 1-2-3-4
	1/4" 140 mm
	1/4" 115 mm
	1/4" 50 mm
	1/4" 100 mm
	1/4" 35 mm
	1/4" 145 mm

Alapanyag: króm-vanádium, krómozott, teljesen polírozott.  
Kivitel: 29 részes készlet fémdobozban.









**HEYGO**

29-3010M



## Dugókulcs készlet, + rátűzőkulcs, 1/4" „SUPERLOCK”

H135 375

Szerszám	Tartalom Méret
 	1/4" 4-4,5-5-5,5-6-7-8-9-10-11-12-13-14 mm
	1/4" 3-4-5-6-7-8 mm
	1/4" TX10-TX15-TX20-TX25-TX27-TX30-TX40
	1/4" 35 mm
	1/4"
	1/4"
	1/4" 50-100mm
	1/4" - 115 mm

Alapanyag: króm-vanádium acél, sima matt króm felület.  
Kivitel: 33 részes készlet, fémdobozban.

**KSTOOLS**

911.0833



Szerszám	Tartalom Méret
	SUPERLOCK 1/4" 4-4,5-5-5,5-6-7-8-9-10-11-12-13-14 mm
	SUPERLOCK hosszú 1/4" 6-7-8-9-10-11-12-13 mm
	TORX-E 1/4" E4-E5-E6-E7-E8
	1/4" - 4-5,5-6,5 mm
	1/4" - PH 1 - PH 2
	1/4" - PZ 1 - PZ 2
	1/4" - 3-4-5-6 mm
	TX8-TX10-TX15-TX20-TX25-TX27-TX30
	SUPERLOCK 1/2" 10-11-12-13-14-15-16-17-18-19-20-21-22-24-27-30-32 mm
	SUPERLOCK hosszú 1/2" 14-15-17-19-22 mm
	1/2" E10-E11-E12-E14-E16-E18-E20-E24
	1/2" 16-21 mm
	1/4" 50 mm
	1/4" 100 mm
	5/16" 8-10-12 mm
	5/16" PH 3 - PH 4
	5/16" PZ 3 - PZ 4
	5/16" 7-8-10-12-14 mm
	5/16" TX40-TX45-TX50-TX55-TX60
	1/4"-1/4"
	1,5 2 2,5 mm
	1/4" 35 mm
	1/4" 110 mm
	1/4" Z45 /5°
	1/2" 125 mm
	1/2" 250 mm
	3/8"-1/2"
	1/2"
	1/2"-5/16"
	1/2" Z45/5° 145 mm

Alapanyag: króm-vanádium acél, sima matt króm felület.  
Superlock belső profillal a tökéletes nyomatékátvitel érdekében a csavarfej lapjára feszül.  
Kivitel: 108 részes krómozott készlet, irányváltós és gyorskioldós, 45 fogú racsnival és kétkomponensű ergonomiai nyéllel.



## Dugókulcs, 1/2"

H145 005 - 025

Méretkód mm	H145...				
	005	010	015	020	025
5	•				
5,5	•				
6	•				
7	•				
8	•	•			•
9	•	•			•
10	•	•	•	•	•
11	•	•	•	•	•
12	•	•	•	•	•
13	•	•	•	•	•
14	•	•	•	•	•
15	•	•	•	•	•
16	•	•	•	•	•
17	•	•	•	•	•
18	•	•	•	•	•
19	•	•	•	•	•
20	•	•	•	•	•
21	•	•	•	•	•
22	•	•	•	•	•
23	•	•	•	•	•
24	•	•	•	•	•
25	•	•	•	•	•
26	•	•	•	•	•
27	•	•	•	•	•
28	•	•	•	•	•
29	•	•	•	•	•
30	•	•	•	•	•
32	•	•	•	•	•
34	•	•	•	•	•
36	•	•	•	•	•



### H145 005

Króm-vanádium acél, krómozott, teljesen polírozott golyófogó horonnyal.  
Hossz: 40 mm



50-6

### H145 010

Króm-vanádium acél, krómozott, teljesen polírozott golyófogó horonnyal.  
Hossz: 40 mm



750-6

### H145 015

**SUPERLOCK**  
Alapanyag: króm-vanádium acél, sima matt króm felület.  
Kivitel: Superlock belső profillal a tökéletes nyomatékátvitel érdekében a csavarfejek lapjára feszül.  
Hossz: 40 mm



911.1210-1232

### H145 020

**TRIPLEplus**  
Alapanyag: olajdzett króm-vanádium acél.  
Kivitel: Triple plus profillal, amely lehetővé teszi, egy kulccsal négy különböző fejkialakítású csavar meghúzását. Egyaránt alkalmas hatlapú, tizenkétszögű és külső TORX-E profilra, sőt sok collméretre is.  
Hossz: 40 mm



916.1210-1224

### H145 025

**CROMEplus**  
Alapanyag: olajdzett króm-vanádium acél.  
Kivitel: Suprelock belső profillal a tökéletes nyomatékátvitel érdekében a csavarfejek lapjára feszül.  
Hossz: 40 mm



918.1208-1236

## Dugókulcs, 12 szögű, 1/2"

H145 030 - 040

Méretkód mm	H145...		
	030	035	040
8	•	•	•
9	•	•	•
10	•	•	•
11	•	•	•
12	•	•	•
13	•	•	•
14	•	•	•
15	•	•	•
16	•	•	•
17	•	•	•
18	•	•	•
19	•	•	•
20	•	•	•
21	•	•	•
22	•	•	•
23	•	•	•
24	•	•	•
25	•	•	•
26	•	•	•
27	•	•	•
28	•	•	•
29	•	•	•
30	•	•	•
32	•	•	•
33	•	•	•
34	•	•	•
36	•	•	•



### H145 030

Króm-vanádium acél, krómozott, teljesen polírozott golyófogó horonnyal.  
Hossz: 40 mm



50-12

### H145 035

Króm-vanádium acél, krómozott, teljesen polírozott golyófogó horonnyal.  
Hossz: 40 mm



750-12

### H145 040

Alapanyag: króm-vanádium acél, sima matt króm felület.  
Hossz: 40 mm



911.1570-1587



## Dugókulcs, hosszú, 1/2"

H145 050 - 060

Méretkód mm	H145...		
	050	055	060
10	•	•	•
11	•	•	•
12	•	•	•
13	•	•	•
14	•	•	•
15	•	•	•
16	•	•	•
17	•	•	•
18	•	•	•
19	•	•	•
20	•	•	•
21	•	•	•
22	•	•	•
24	•	•	•
26	•	•	•
27	•	•	•
30	•	•	•
32	•	•	•



**H145 050**  
Króm-vanádium acél, krómozott, teljesen polírozott golyófogó horonnyal.  
12-szög profil  
Hossz: 80 mm



**HEYCO**  
50-19



**H145 055**  
SUPERLOCK  
Alapanyag: króm-vanádium acél, sima matt króm felület  
Kivitel: Suprelock belső profillal a tökéletes nyomatékvitel érdekében a csavarfejek lapjára feszül.  
6-szög profil  
Hossz: 75 mm



**KSTOOLS**  
911.1240-1256



**H145 060**  
TRIPLEplus  
Alapanyag: olajezett króm-vanádium acél  
Kivitel: Triple plus profillal, amely lehetővé teszi, egy kulccsal négy különböző fejkialakítású csavar meghúzását teszi lehetővé. Egyaránt alkalmas hatlapú, tizenkétszögű és külső TORX-E profilra, sőt sok collméretre is.  
Hossz: 75 mm



**KSTOOLS**  
916.1240-1251

## Dugókulcs, collos 1/2"

H145 065 - 070

Méretkód coll	H145...	
	065	070
3/8	•	•
7/16	•	•
1/2	•	•
9/16	•	•
19/32	•	•
5/8	•	•
11/16	•	•
3/4	•	•
25/32	•	•
13/16	•	•
7/8	•	•
15/16	•	•
31/32	•	•
1	•	•
1.1/16	•	•
1.1/8	•	•
1.3/16	•	•
1.1/4	•	•



**H145 065**  
6-szög profil  
Alapanyag: króm-vanádium acél  
Kivitel: SUPERLOCK belső profillal a tökéletes nyomatékvitel érdekében a csavarfejek lapjára feszül.



**KSTOOLS**  
918.1301-1315



**H145 070**  
12-szög profil  
Alapanyag: króm-vanádium acél, krómozott, teljesen polírozott golyófogó horonnyal  
Hossz: 40 mm



**HEYCO**  
50-12

## Dugókulcs alufelni szereléséhez 1/2"

H145 075 - 080



Méretkód mm	szín	H145...	
		075	080
15	zöld	•	•
17	kék	•	•
19	sárga	•	•
21	piros	•	•
22	zöld	•	•



**H145 075**  
Alapanyag: Króm-molibdén DIN 3121 szerint  
Kivitel: műanyag köpennyel ellátva, ami az alufelni sérülésmentes szerelését biztosítja  
Hossz: 85 mm

**KSTOOLS**  
515.2015-2022



**H145 080**  
Hosszú  
Alapanyag: Króm-molibdén DIN 3121 szerint  
Kivitel: műanyag köpennyel ellátva, ami az alufelni sérülésmentes szerelését biztosítja  
Hossz: 150 mm

**KSTOOLS**  
515.2040-2042



## Dugókulcs, 1/2", „TORX-E”

H145 095 - 105

Méretkód	Méret	mm	H145...	
			095	105
E 10	9,42		•	•
E 11	10,08		•	•
E 12	11,17		•	•
E 14	12,90		•	•
E 16	14,76		•	•
E 18	16,70		•	•
E 20	18,49		•	•
E 22	20,24		•	•
E 24	22,16		•	•



### H145 095

Külső - TORX csavarokhoz.  
Alapanyag: króm-vanádium  
krómozott, teljesen polírozott,  
golyófogó horonnyal.  
Hossz: 36-40 mm



**HEYGO**

50-20

### H145 105

Hosszú  
Alapanyag: króm-vanádium acél,  
sima matt króm felület.  
Hossz: 75 mm



**KSTOOLS**

911.4423-4431

## Dugókulcs, gépi, 1/2", „TORX-E”

H145 110

Méretkód Méret	E10	E11	E12	E14	E16	E18	E20	E22	E24

Hosszú  
Alapanyag: Króm-molibdén acél,  
foszfátzott felülettel,  
DIN 3121 szerint, barnított.  
Hossz: 75 mm



**KSTOOLS**

515.1051-1059

## Dugókulcs, gépi, 1/2”

H145 115 - 130

Méretkód	mm	H145...			
		115 L mm	120 L mm	125 L mm	130 L mm
8			•	•	
9				•	
10		•	•	•	•
11		•	•	•	•
12		•	•	•	•
13		•	•	•	•
14		•	•	•	•
15		•	•	•	•
16		•	•	•	•
17		•	•	•	•
18		•	•	•	•
19		•	•	•	•
20		•	•	•	•
21		•	•	•	•
22		•	•	•	•
23		•	•	•	•
24		•	•	•	•
25		•	•	•	•
26		•	•	•	•
27		•	•	•	•
28		•		•	•
29		•		•	•
30		•	•	•	•
31				•	•
32		•		•	•



### H145 115

6 szög fejjel  
Alapanyag: króm molibdén  
acél, foszfátzott  
Kivétel: extra vékonyfalú  
Hossz: 40 mm

1/2 **HEYGO**



3800



### H145 120

6 szög fejjel  
Alapanyag: króm-vanádium  
acél, foszfátzott  
Hossz: 40 mm

1/2 **HEYGO**



6300



### H145 125

6 szög fejjel  
Alapanyag: króm-molibdén  
acél, foszfátzott felülettel,  
DIN 3129 barnított

1/2 **KSTOOLS**



515.1008-1032



### H145 130

12 szög fejjel  
Alapanyag: króm-molibdén  
acél, foszfátzott felülettel,  
DIN 3129 barnított





1/2 **KSTOOLS**



515.0910-0924

## Dugókulcs készlet, 1/2"

H145 765

Szerszám	Tartalom Méret
 SP	1/2" - 10-11-12-13-14-15-16-17-18-19-20-22 mm
	1/2" - 275 mm
	1/2" - 300 mm
	1/2" - 250 mm











**HEYCO**

70-3010-M

Alapanyag: króm-vanádium acél, krómozott, teljesen polírozott  
Kivitel: 15 részes készlet fémdobozban.

## Dugókulcs készlet, 1/2"

H145 775 - 785

Szerszám	Tartalom Méret	H145...		
		775	780	785
 SP	1/2" - 12-13-14-15-16-17-18-19-20-21-22-23-24-26-27-28-30-32 mm	•		
 SP	1/2" - AF 3/8-7/16-1/2-9/16-19/32-5/8-11/16-3/4-25/32-13/16-7/8-15/16-31/32-1.1/16-1.1/8-1.3/16-1.1/4			•
 SP	1/2" - 12-13-14-15-16-17-18-19-20-21-22-23-24-26-27-28-30-32 mm		•	
	1/2" - 405 mm	•	•	•
	1/2" - 275 mm	•	•	•
	1/2" - 300 mm	•	•	•
	1/2" - 125 mm	•	•	•
	1/2" - 250 mm	•	•	•
	1/2" - 80 mm	•	•	•



### H145 775

Alapanyag: króm-vanádium acél, krómozott, teljesen polírozott  
Kivitel: 24 részes készlet fémdobozban.

**HEYCO**

75-0010-M

### H145 780

Alapanyag: króm-vanádium acél, krómozott, teljesen polírozott  
Kivitel: 24 részes készlet fémdobozban.

**HEYCO**

75-3010-M

### H145 785









Alapanyag: króm-vanádium acél, krómozott, teljesen polírozott  
Kivitel: 24 részes készlet fémdobozban.

**HEYCO**

75-1010-AF

## Dugókulcs + rátűzőkulcs készlet, 1/2"

H145 795

Szerszám	Tartalom Méret
 SP	1/2" - 12-13-14-15-16-17-18-19-20-21-22-23-24-26-27-28-30-32 mm
	1/2" - 270 mm
	1/2" - 8x1,2 - 12x2,0 - 14x2,5
	1/2" - 5-6-8-10-12-14-17 mm
	1/2" - PH No. 2-3-4
	1/2" - 300 mm
	1/2" - 125 mm
	1/2" - 250 mm
	1/2" - 80 mm

Alapanyag: króm-vanádium acél, krómozott, teljesen polírozott  
Kivitel: 36 részes készlet fémdobozban.







**HEYCO**

77-0-M



## Dugókulcs készlet, 1/2"

H145 800 - 805

Szerszám	Tartalom Méret	H145...	
		800	805
 1/2" - 10-11-12-13-14-15-16-17-18-19-20-22 mm		•	
 1/2" - 10-11-12-13-14-15-16-17-18-19-20-22 mm			•
 1/2" - 260 mm			•
 1/2" - 265 mm		•	
 1/2" - 300 mm		•	•
 1/2" - 250 mm		•	•



### H145 800

Alapanyag: króm-vanádium acél, krómozott  
Kivitel: 15 részes készlet fémdobozban.



770-0-M



### H145 805









Alapanyag: króm-vanádium acél, krómozott  
Kivitel: 15 részes készlet fémdobozban.



770-80-M

## Dugókulcs készlet, 1/2"

H145 810 - 815

Szerszám	Tartalom Méret	H145...	
		810	815
 1/2" - 10-11-12-13-14-15-17-19-22-24-27-30-32 mm		•	
 1/2" - 10-11-12-13-14-15-17-19-22-24-27-30-32 mm			•
 1/2" - 260 mm		•	•
 1/2" - 300 mm		•	•
 1/2" - 125 mm		•	•
 1/2" - 250 mm		•	•
 1/2" - 73 mm		•	•
 1/2" - 20,8 mm		•	•



### H145 810

Alapanyag: króm-vanádium acél, krómozott  
Kivitel: 15 részes készlet fémdobozban.



772-53-M



### H145 815











Alapanyag: króm-vanádium acél, krómozott  
Kivitel: 15 részes készlet fémdobozban.



772-83-M

## Dugókulcs + rátűzőkulcs készlet, 1/2"

H145 845

Szerszám	Tartalom Méret
 1/2" - MM 10-11-12-13-14-15-16-17-18-19-20-21-22-23-24-27-30-32	
 1/2" - MM 10-13-17-19	
 1/2" - SW 5-6-8-10-12-14	
 1/2" - TX30-TX40-TX45-TX50	
 1/2" - 250 mm	
 1/2" - 250 mm	
 1/2" - 125 mm	
 1/2" - 55 mm	
 1/2" - 16 mm	
 1/2" - 21 mm	

Alapanyag: króm-vanádium acél.  
Kivitel: SP speciális profillal a tökéletes nyomatékátvitel érdekében a csavarfejek lapjára feszül.  
39 részes készlet műanyag dobozban.











50853-3015



## Dugókulcs készlet, 3/4"

H150 270 - 280

Szerszám	Tartalom Méret	H150...		
		270	275	280
 3/4" - 22-24-27-30-32-36-38-41-46-50 mm			•	
 3/4" - 22-24-27-30-32-36-38-41-46-50 mm		•		
 3/4" - AF 7/8-15/16-1-1.1/16-1.1/8-1.1/4-1.1/2-1.5/8-1.3/4-2				•
 3/4" - 490 mm			•	
 3/4" - 490 mm		•		•
 3/4" - 485 mm		•	•	•
 3/4" - 200 mm		•	•	•
 3/4" - 400 mm		•	•	•



### H150 270

Alapanyag: króm-vanádium, krómozott  
Kivitel: 14 részes készlet fémdobozban.

**HEYCO**  
101-80M

### H150 275

Alapanyag: króm-vanádium, krómozott  
Kivitel: 14 részes készlet fémdobozban.

**HEYCO**  
101-0M







### H150 280

Alapanyag: króm-vanádium, krómozott  
Kivitel: 14 részes készlet fémdobozban.

**HEYCO**  
101-60AF

## Dugókulcs készlet, 3/4"

H150 285

Szerszám	Tartalom Méret
 3/4" - 19-21-22-23-24-26-27-29-30-32-35-36-38-41-46-50 mm	
 3/4" - 100 mm	
 3/4" - 200 mm	
 3/4" - 400 mm	
 3/4" - 450 mm	
 3/4" - 24Z, 500 mm	









Alapanyag: króm-vanádium acél,  
sima matt króm felület  
21 részes készlet műanyag dobozban.

**KSTOOLS**  
911.0721

## Dugókulcs készlet, 3/4"

H150 290

Szerszám	Tartalom Méret
 3/4" - AF 3/4-13/16-7/8-15/16-1-1.1/16-1.1/8-1.3/16-1.1/4-1.5/16-1.3/8-1.7/16-1.1/2-1.5/8-1.3/4-2	
 3/4" - 100 mm	
 3/4" - 200 mm	
 3/4" - 400 mm	
 3/4" - 450 mm	
 3/4" - 24Z, 500 mm	



Alapanyag: króm-vanádium acél,  
sima matt króm felület  
21 részes készlet műanyag dobozban.

**KSTOOLS**  
911.0751

## Dugókulcs, 1"

H155 005 - 010

Méretkód	H155...	
	005	010
36	•	•
38	•	•
41	•	•
46	•	•
50	•	•
54	•	•
55	•	•
58	•	•
60	•	•

Méretkód	H155...	
	005	010
63		•
65	•	•
67		•
70	•	•
71		•
75	•	•
77		•
80	•	•



### H155 005

Alapanyag: króm-vanádium acél,  
krómozott.  
Kivitel: 12 szögletű fejjel,  
belső négyszög furattal,  
biztosító gombbal.

1

SP

**HEYCO**  
105-12

### H155 010

Alapanyag: króm-vanádium acél,  
sima matt króm felület  
Kivitel: 6 szögletű fejjel

1

HEX

**KSTOOLS**  
911.1036-1080